

Goniophotometer



Company synopsis

Pleiades Instruments is an optoelectronic system maker, designing and manufacturing for you specific systems such as photometric measurement and customized systems. Designing high performance devices, our team assists you in standard and specific need.



Our devices are used by automotive and general lighting industry for the development, the testing, the calibration and the production of different types of products such as rear or head lamps.

Goniophotometers and Multicells systems, by analyzing the spatial distribution and the photometric properties of different kinds of sources, will help you for the certification of your devices, according to many different standards (SAE, ECE, Japan, ERAI, GB) on 10 or 25 meters distance.

Regulations and Standards



Regulations and standards impose conditions on the spatial repartition but also on the spectral components of lamps. For instance, ECE regulation imposes new headlamps to emit a white light.

Manufacturers of automotive lighting systems need testing and qualifying tools throughout the development and manufacture of their products. To do so, they need measurements using one or several photometric sensors and mobile elements to do specific evaluations.

Our goniophotometers have been developed to make the characterization of many kinds of products, precise and easy at the same time.

Goniophotometer

Goniophotometer provides optimal conditions to obtain high precision. The product points to one or more photometric sensors, using a motorized, self-working stage.

Different systems are available: Goniophotometer System for signaling measurement (GES_S), for lighting measurement (GES_L), for both (GES_SL) and with retrometer.

The systems have 2 rotating axes and 3 translation axes to allow any angular position measurement you need.

Our products can be used to test signaling functions: tail, stop, turn indicator, fog, reverse, lateral tail, CHMSL, DRL, reflectors, lighting functions: high beam, low beam...

Some options can be added to the system such as:

- ❖ Additional cells (up to 5 cells)
- ❖ Panel for light projection.



Our goniophotometers have many assets such as:

- ❖ Stand alone systems (space saving and easier to install) thanks to the control rack inserted inside the device.
- ❖ Easy settings amplitude thanks to the traversing range.
- ❖ High angular precision (0.01° precision).
- ❖ Many supplies channels available: 7 channels multiplexer on product interface.
- ❖ Light (300kg) and compact.
- ❖ High maximum load (25kg/55pounds).
- ❖ Large measurement range: 0.0001 to 200000 lux.
- ❖ Thanks to their brand new design, our devices are among the most compact goniophotometers on the market.
- ❖ Easy alignment of products thanks to a laser.
- ❖ Retro-reflectometers are available for the characterization of reflectors, for instance.
- ❖ Remote control.
- ❖ High quality repeatability of measurements.
- ❖ Easy to use software, allowing different kind of measures, with a large range of standards and products.
- ❖ Our devices allow tests and qualifications according to many different standards: ECE, SAE, Japan... etc.
- ❖ High quality maintenance with our reliable, timely, cost effective services for soft/hardware and our reactive after sales service.
- ❖ Reasonable price.



Goniophotometer characteristics:

	Lighting	Signaling
Measurement cells	Lighting cell and/or Signaling cell	
Photometric range	Up to 200 000 lux	Up to 10 000 cd
Photometric resolution	4 digits or 10^{-4} lux	4 digits or 10^{-2} cd (at 10m)
Display frequency	1 Hz	
Goniometer Amplitude	Elevation: $\pm 20^\circ$	
	Rotation: $\pm 90^\circ$	
	Vertical: - 500mm	
	Transverse: ± 250 mm	
	Depth: ± 150 mm	
Power Supply	Two power supplies: 18V/20A	One power supply: 25V/7A
	Setting accuracy	
	0,01mV $\pm(0.1\%$ FS) 0,01mA $\pm(0.2\%$ FS)	$1\mu\text{V} \pm(0,05\%$ FS) 0,01mA $\pm(0,2\%$ FS)
	Ripple & Noise (RMS)	
	< 1mV, < 3mA	< 500 μV , < 2mA
Goniometer size	Height: 1.12m	
	Width: 0.8m	
	Length: 1.85m	
	Weight: 300Kg	
PC information	Processor: DualCore 2.7 GHz	
	RAM: 2Go	
	Software: ALPES, Pack Office	
Power requirements	230V/50Hz/10A or 110V/60Hz/10A	

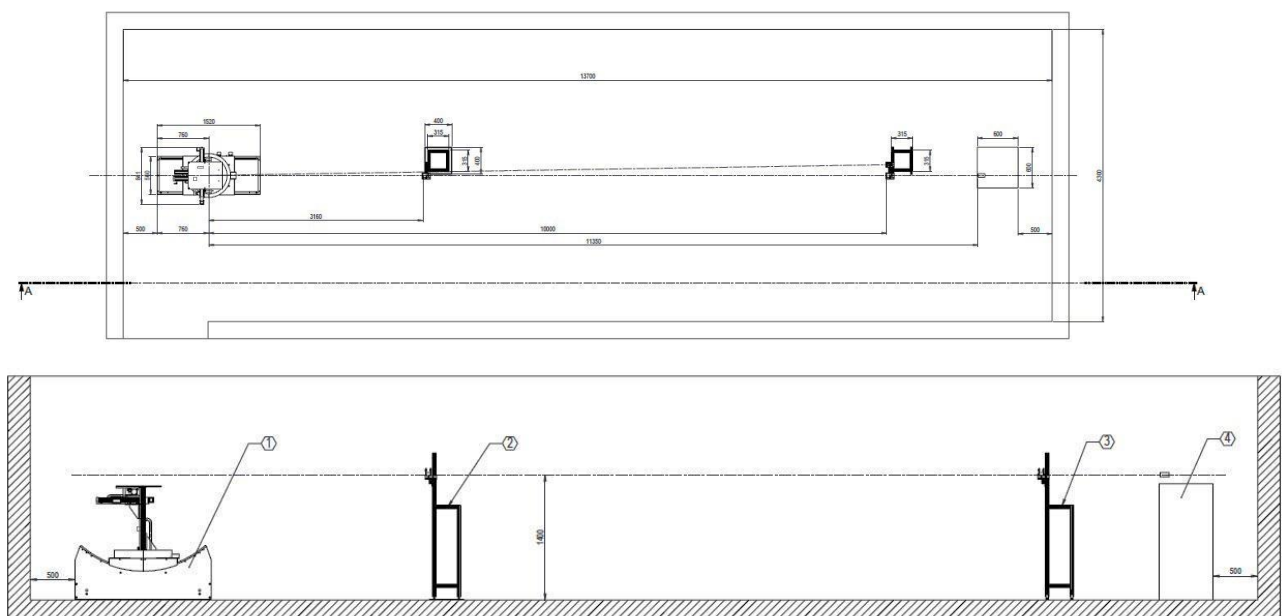

Goniophotometers & options

Pleiades Instruments has designed different kind of goniophotometers to fit the specific needs of our clients. The designation of our devices is the following:

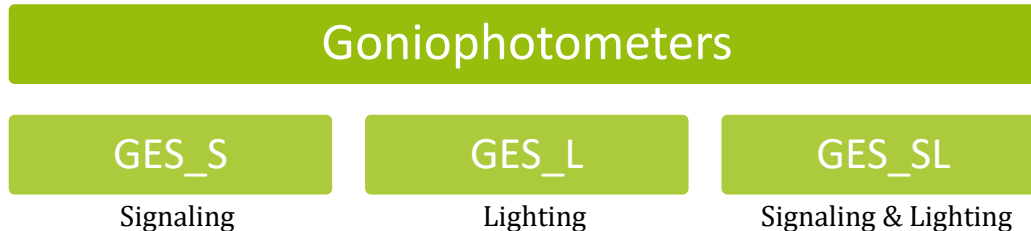

You will find below options and spare parts that can be added to our system:

Power supply GES_OPS	<ul style="list-style-type: none">• Agilent power supply• TTI power supply
Retrometer GES ORM	<ul style="list-style-type: none">• Retrometer module
Lens GES_OSL	<ul style="list-style-type: none">• Spare lens
Wires GES_OAW	<ul style="list-style-type: none">• Additional specific wires to connect products to power supply
Reference Lamp GES_ORL	<ul style="list-style-type: none">• Signaling reference lamp• Lighting reference lamp
Upon request	<ul style="list-style-type: none">• Colorimetry option• Maintenance contract

Options

Power supplies GES_OPS

Power supplies are used to adjust the current/voltage going through products. TTI power supply is used for lighting equipments (18V-20A, accuracy of measurement: 0,01%) whereas Agilent power supply is used for signaling systems (25V-7A, accuracy of measurement: 0,05%).

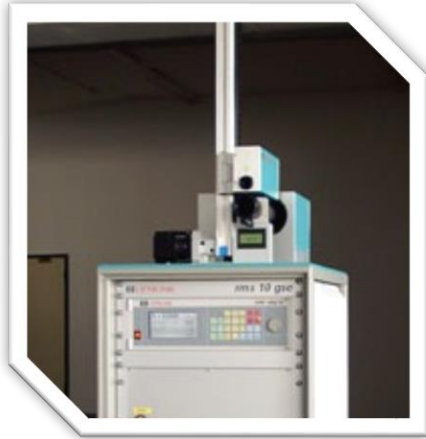

Lens GES_OSL

Lenses are used to reduce the distance between products and detectors. Spare lenses especially designed for goniophotometers systems, are available.

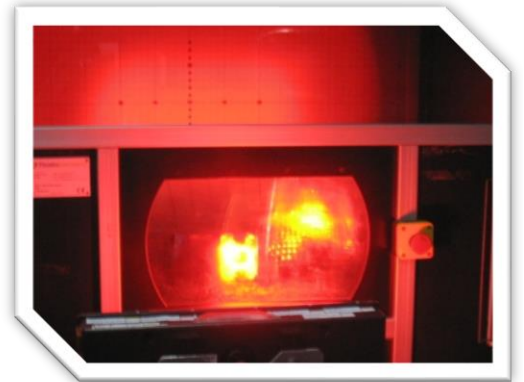

Wires GES_OAW

Pleiades Instruments provides specific spare 3m wires to connect products to power supplies (2 wires for regulation & 2 wires for power).

Reference lamps GES_ORL

Standard intensity/flux lamps are used to calibrate photometric devices. Pleiades Instruments provides signaling and lighting reference lamps certified by an accredited agency.



For measurements, we use the sign convention explained on the left, the product is placed at the center of the sphere.

The cell detector is at 10 or 25m from the lamp, depending on the kind of device you are testing.

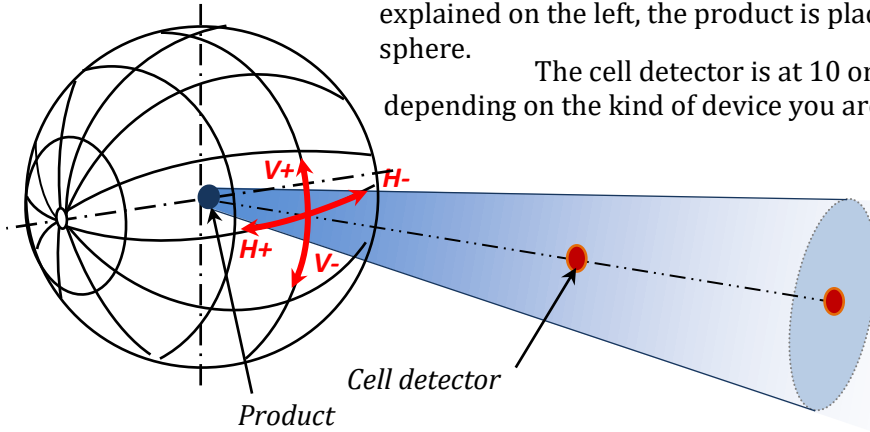

Photometer

For the detection, we use a high precision luxmeter, for repeatable and precise measures of illuminance. The photometer head, made with a $V(\lambda)$ filter, is placed on the optical axis.

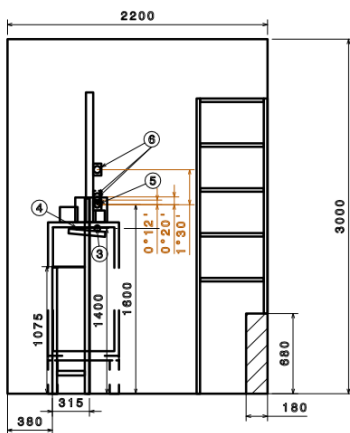

Reception Frame –Front View-
Scale 1 :20

The impingement on the photoelectric cell of stray light, due to reflections or diffusion effects, is reduced to a minimum thanks to a stray light tube positioned in front of the photometer.

Used in conjunction with our goniophotometers, this system allows very high precision measurement of illuminance, luminous intensity or luminous flux, for Research and Development or even for the control of process.



Retro-reflectometer

In order to test and certify products like reflectors, according to ECE or SAE regulations, Pleiades Instruments can provide a retro-reflectometer.

The illumination projector lights up the product you need to certify and the receiver analyzes the reflected light.

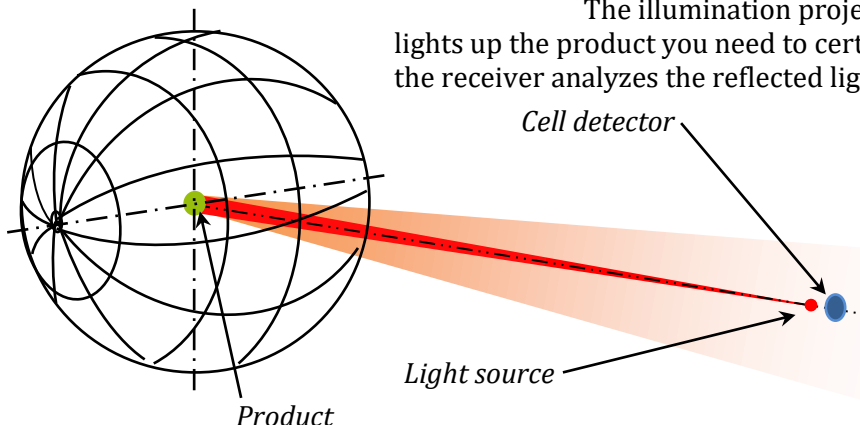

Used with a goniophotometer, this tool allows a high precision measurement of retro-reflectance of many devices such as reflectors or mirrors.

Software: ALPES.

Our system is delivered with our fully applicative software called ALPES (Automotive Lighting Photometric Equipment Software). ALPES is an application used for controlling and running the photometric systems manufactured by Pleiades Instruments. It offers a user friendly and simplified user interface for operators in production mode, or a fully customizable software for administrators and Research & Development users.

ALPES is used for all the systems sold by Pleiades Instruments: goniophotometer and multi-cells, and for different products: signaling and lighting.

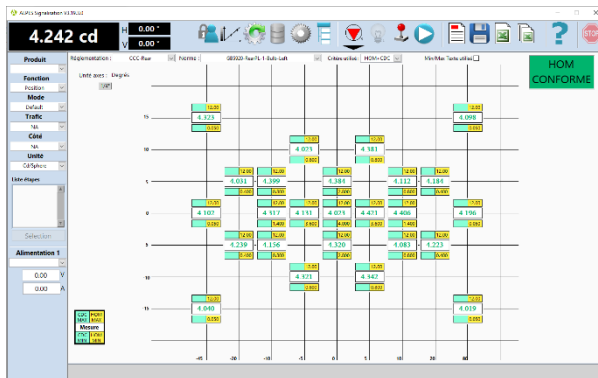

This software allows a large kind of measurements for complex analysis, production... A basis of standards that can be tested is provided with the system. ALPES provides a report indicating if a measurement is conform to the standard. Moreover, lots of measurement types are available: point, scan, cut, succession of measurements on the same products and cutoff stability.

The administrator mode allows the user to prepare the measurements and calibrate the cells if necessary; then, the operator has just to start the measurement and analyze results.

ALPES is a very flexible software which means that it is possible for users to configure all measurements. Updates are also regularly available online.

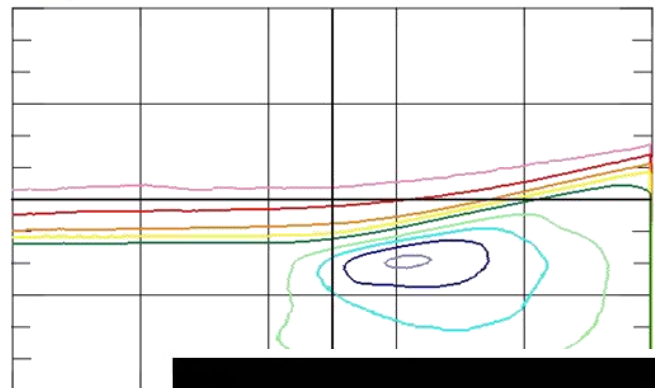
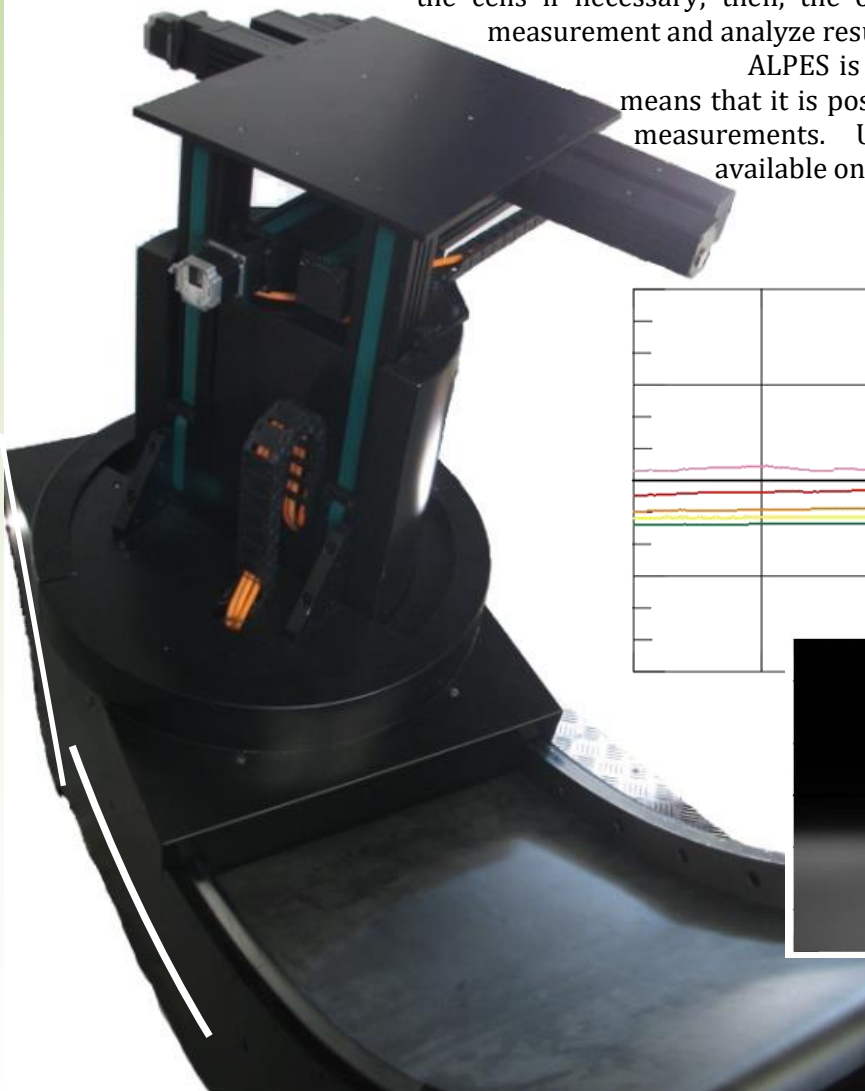



Certificat

Certificate

N° 2017/74946.3

Page 1 / 1

AFNOR Certification certifie que le système de management mis en place par :
AFNOR Certification certifies that the management system implemented by:

PLEIADES INSTRUMENTS

pour les activités suivantes :
for the following activities:

ETUDES R&D, FABRICATION ET MAINTENANCE DE MATERIEL DE MESURE OPTO-ELECTRONIQUE.

RESEARCH AND DEVELOPMENT ENGINEERING, MANUFACTURING AND MAINTENANCE OF OPTO-ELECTRONIC MEASUREMENT SYSTEMS.

a été évalué et jugé conforme aux exigences requises par :
has been assessed and found to meet the requirements of:

ISO 9001 : 2015

et est déployé sur les sites suivants :
and is developed on the following locations:

7 RUE ANTOINE POLOTTI FR-38000 GRENOBLE

Ce certificat est valable à compter du (année/mois/jour)
This certificate is valid from (year/month/day)

2023-04-18

Jusqu'au
Until

2026-04-06

Ce document est signé électroniquement. Il constitue un original électronique à valeur probatoire.
This document is electronically signed. It stands for an electronic original with probatory value.

Julien NIZRI
Directeur Général d'AFNOR Certification
Managing Director of AFNOR Certification



Flashez ce QR
Code pour vérifier la
validité du certificat

Seul le certificat électronique, consultable sur www.afnor.org fait foi en tant que tel de la certification de l'organisme. The electronic certificate only, available at www.afnor.org attests à real-time that the company is certified. Accreditation COPRAC n° 4 0001. Certification de Systèmes de Management. Fiche descriptive sur www.afnor.org.
COPRAC autorisation n°4 0001. Management System Certification. Scope available on www.afnor.org.
AFNOR est une marque déposée. AFNOR is a registered trademark - ©2021 AFNOR 07/2021

Pleiades Instruments

7 rue Antoine Polotti
38000 Grenoble, FRANCE
Phone: +33 (0)4 27 19 45 57
contact@pleiades-instruments.com
www.pleiades-instruments.com

